



Expedition II

Zero Clearance

Installation Manual



The Expedition II Zero Clearance Box allows the product to be installed into a combustible wall, with minimum clearances and without brick or block work using the framing dimensions and clearances illustrated within this installation manual.

Zero clearance box dimensions

Isometric View

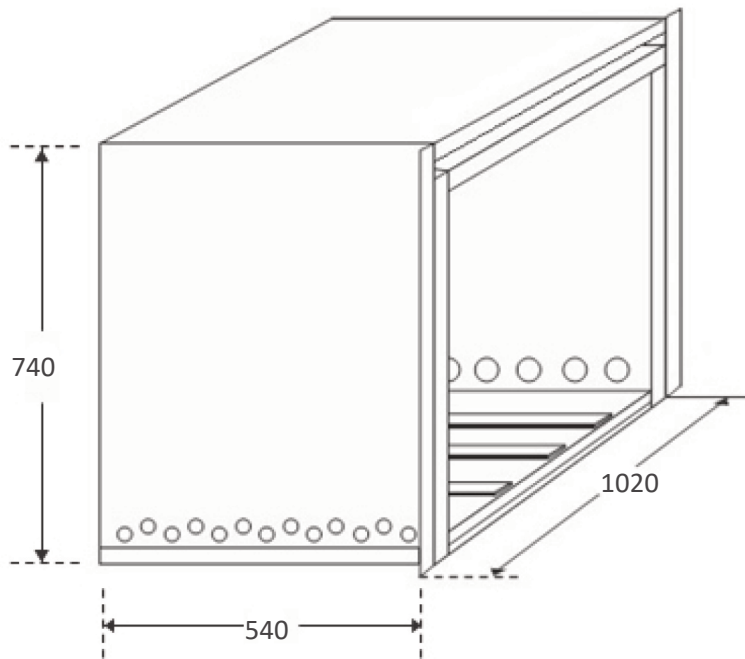

Section View

Elevation View

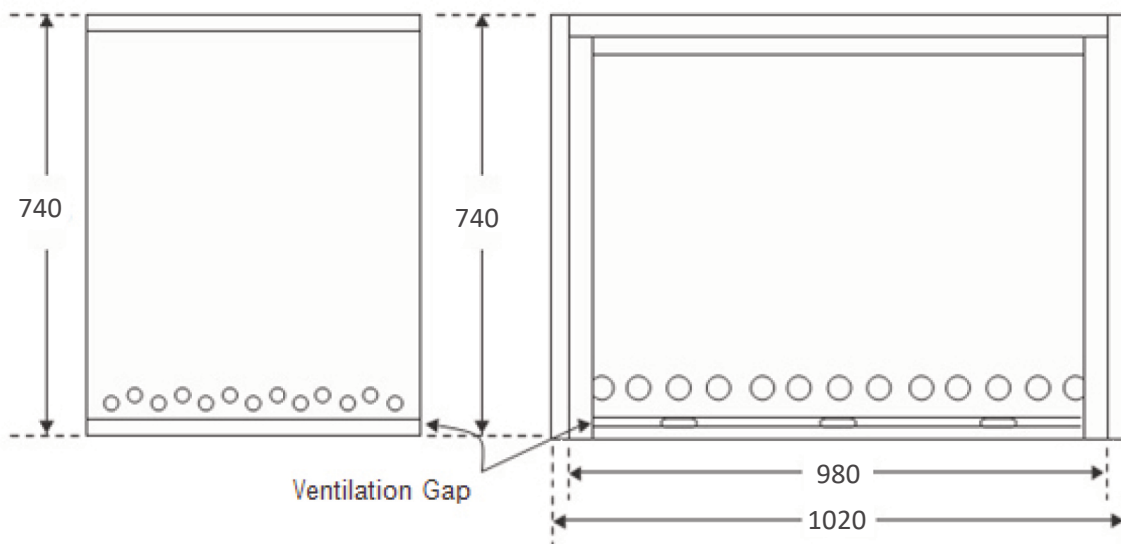

**Dimensions are subject to change at our discretion, please check with our office for further details.

Zero Clearance Box Assembly Details

Step 1

Lay down the bottom panel with folded edges facing upwards, and the non-folded edge turned frontwards.



Step 2

Screw rear spacer, inner left, inner right and inner back panels together, with the returns facing outwards.

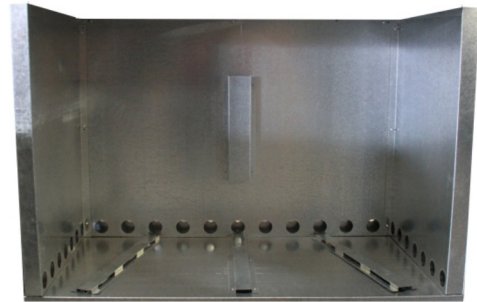

Step 3

Screw the inner top panel in place.



Step 4

Screw the 200mm collar in place.

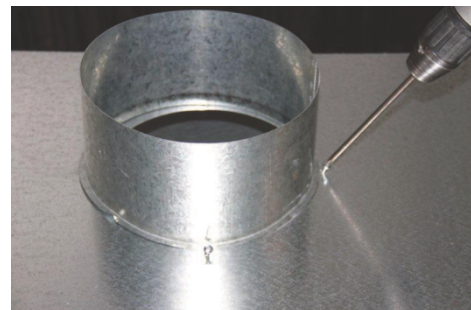

Step 5

Screw the outer left, outer right and outer rear panels in place with the vent holes to the bottom, and the returns facing outwards



Step 6

Screw the outer top panel into place.



Step 7

Screw the third skin collar in place



Step 8

Stainless bend is supplied to match the height of the triple skins.



The triple skin flue must be installed with a Zero Clearance Box, as per Australian standards. A 25mm clearance from the outer triple casing to any combustible material must be maintained.

Please see heater owner's manual for other clearances and more information.

* Images for illustration purposes only, some details may change

Timber framing guide

Front Elevation

Frame opening required: 1220mm (w) x 1090mm (h) x 590mm (d)

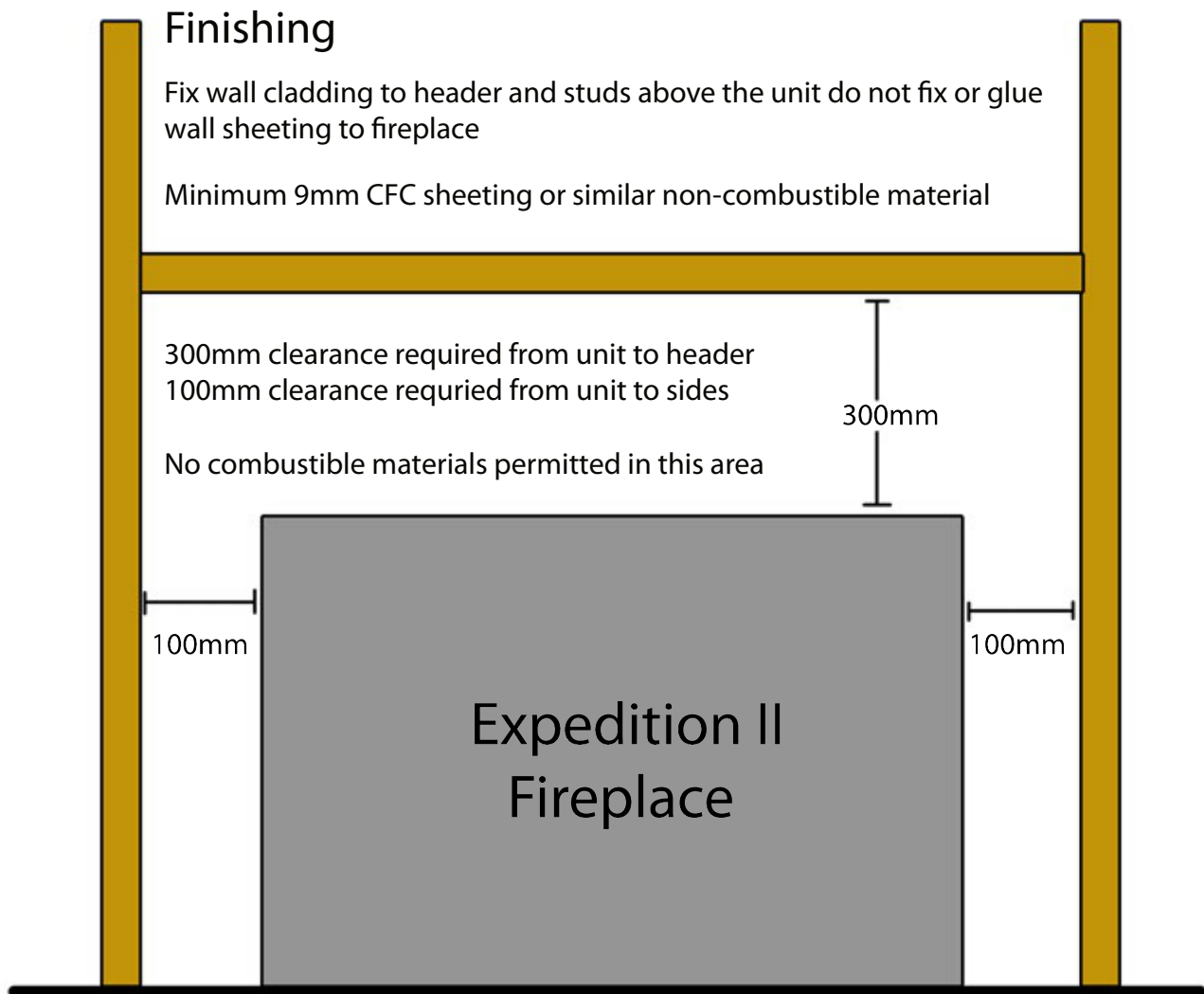

Floor Protection Requirements

The unit must be installed on 30mm thick compressed board, minimum floor protection required below the unit is 1025mm deep x 1220mm wide x 30mm thick. The projection in front of the unit 450mm x 1220mm wide with the unit positioned centered on the floor protection right and left and 50mm forward from the back edge.

Timber framing guide

Side Elevation

Frame opening required: 1220mm (w) x 1090mm (h) x 590mm (d)

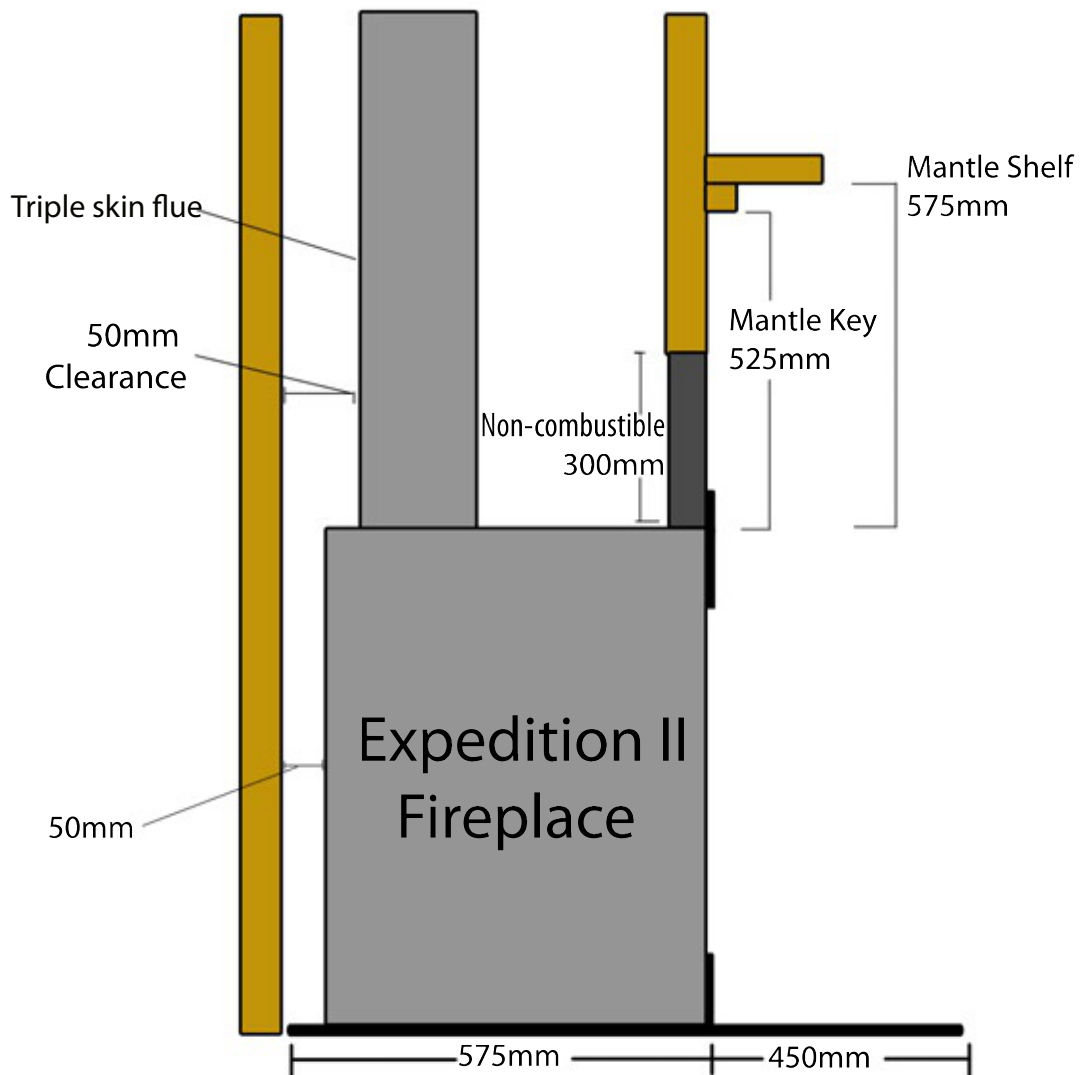

Mantle Guide

Mantle Leg Clearances

90mm from Fascia

Max projection of 70mm

Mantle Key 1100mm from hearth

Max projection of 30mm

Mantle Shelf 1150mm from hearth

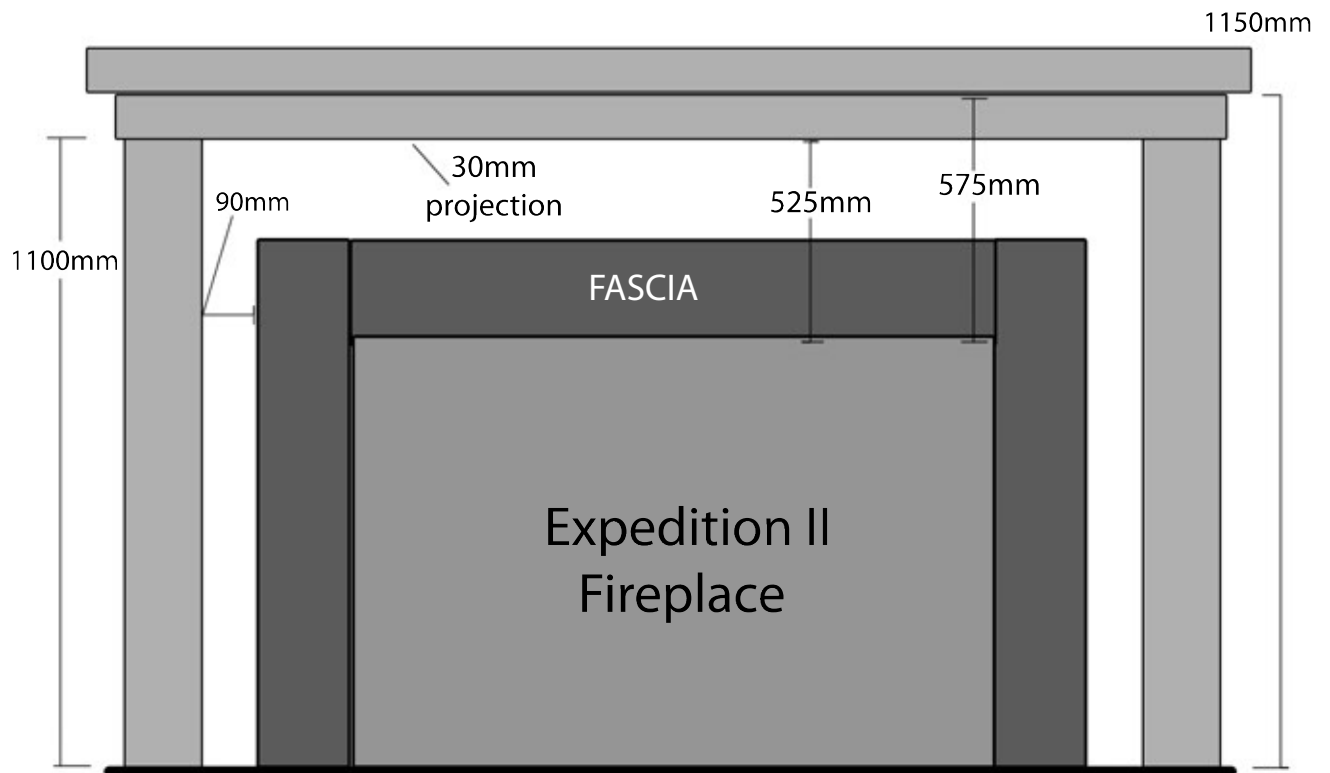

KIT - Component Listing



BOTTOM PANEL

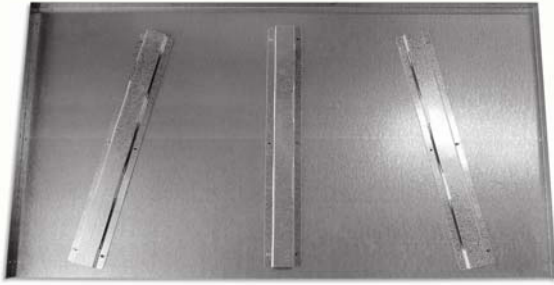

INNER TOP PANEL

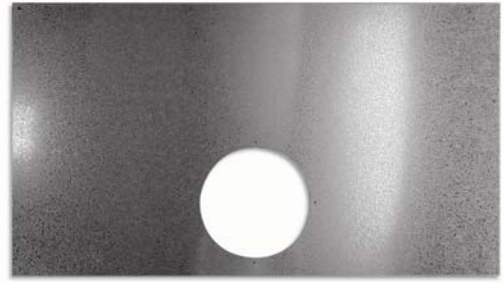

INNER SIDE PANELS

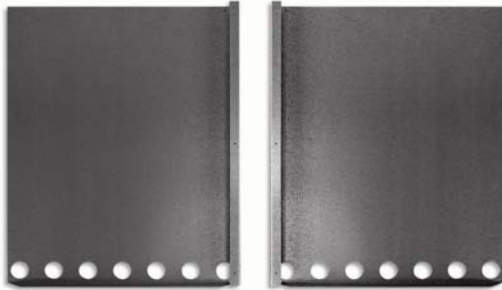

OUTER TOP PANEL

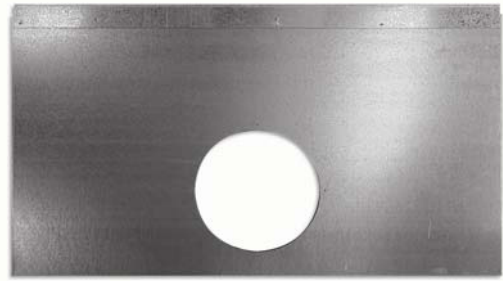

OUTER SIDE PANELS

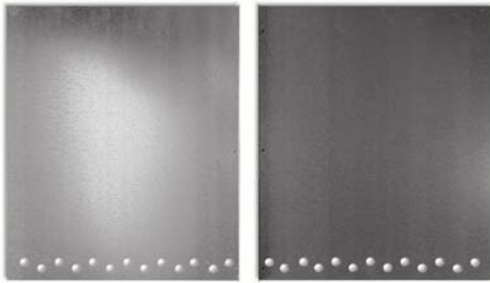

INNER BACK PANEL

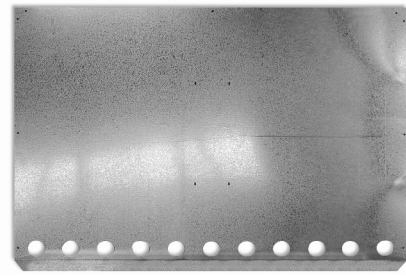

OUTER BACK PANEL

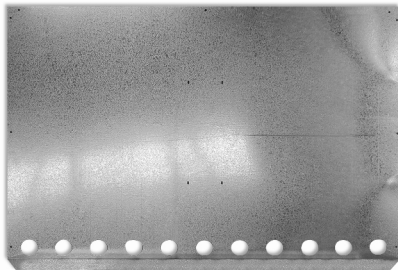

15 DEGREE STARTER ADAPTER



2ND SKIN COLLAR



TRIPLE SKIN COLLAR



* Images for illustration purposes only, some details may change