

visionLINE™

FIREPLACE SYSTEMS

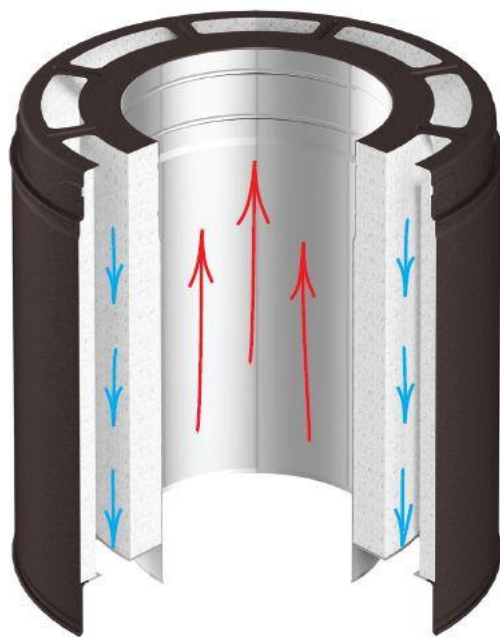

Safety Vent AIR 200 (8") Instruction Manual



VisionLINE Safety Vent AIR 200 (8") Flue System

Thank you for purchasing a VisionLINE AIR flue system for your slow combustion fireplace. Please read this manual carefully to ensure the correct installation of the flue system.

VisionLINE Safety Vent AIR has been tested to Appendix F of Joint Australian & New Zealand Standard 2918 per report ASTF 21074 issued on 20th September 2021.

It is also certified for BAL-40 and BAL-FZ zones when installed with outside air direct connection components or the outer stove pipe opening is sealed on non-outside air adaptable fireplaces.

This flue system is fully approved to EN CE 1856-1 and EN CE 1859 which covers thermal clearance, compression testing, tensile strength, wind tunnel testing and condensation (water vapor) ingress.

The flue system is tested according to Appendix B of AS/NZS2918:2018 on solid fuel appliances with KW outputs up to 17KW with the Visionline Safety Vent 200 (8") Air Flue kit.

Visionline Safety Vent Air Flue kit can be used to replace similar flue kits that use a 8" active and rear 900mm flue shield, solid or decromesh casing below the ceiling penetration on appliances with an average high burn rate kw output of less than 17kw under opinion letter xxxxx by Australian Solid Fuel Testing dated 17th August 2022.

This system **IS NOT** designed to be used on insert fireplaces with an air cooled zero clearance box

Flue System Specifications

VisionLINE Safety Vent AIR pipe is a three-layer twist lock steel pipe with associated air supply consisting of flues in Ø202 mm of 0.6 mm 316L stainless steel, insulated with 25 mm Morgan Frax ceramic insulation with a density of 128 kg / m³, air gap of 20 mm, 20 mm Morgan Frax ceramic insulation 128 kg / m³ and outer wall of 0.5 mm SS 304 stainless steel.

VisionLINE Stove Pipe AIR is a double layer pipe 202mm of 0.6mm 316L stainless steel with added 0.5mm carbon steel draft assist layer and a 0.5mm 304L stainless outer layer gasket seal for air intake.

All pipe and terminations are powder coated in Forrest Paints satin black.

Warranty

Your VisionLINE Safety Vent AIR system is covered by a ten (10) year manufacturers warranty on defects to the flue system due to manufacture. This does not cover damage due to incorrect installation or abuse of the product beyond specification.

VisionLINE insulated air intake flue system

200mm (8") insulated stainless pipe

Please read these assembly instructions carefully prior to installation. To be installed by a qualified installer only, please check local requirements for qualification requirements. Incorrect installation is a fire risk and will result in a loss of warranty.

Distance required to combustible materials

The minimum distance of clearance to a combustible material for the VisionLINE Safety Vent Air pipe is 25mm. VL stove pipe (non-insulated double wall pipe used below the ceiling) must have a minimum of 100mm clearance to combustible materials.

There is no clearance requirement for the outside air snorkel as it's a cold air intake.

VisionLINE Safety Vent AIR pipe meets the requirements of the NS-EN 1856-1 and NS-EN 1858 steel chimney test method, with regards to combustion material for the T450 and G50. This system has also been tested to Australian Standards 2918 Appendix F for Thermal Testing of Flue Systems and Flue System Clearances.

In Australia and New Zealand, this flue system can ONLY be used for solid fuel systems (Wood).

Preparation

Before installation, planning is essential for an efficient, safe and cost-effective installation. ONLY VisionLINE safety vent AIR and VL Stove Pipe parts can be used for installation. Improvised parts or blending with other types of flue systems is not allowed. This will void the warranty and is a fire risk. It is the fireplace clearance requirements to combustible material that determines the flue location in the building. Always read the installation manual from the manufacturer of the fireplace in conjunction with this installation manual for the flue pipe.

This installation manual covers the method whereby the safety vent is suspended and supported within the roof structure and adjustable sections are used. For a cleaner finish, adjustable sections do not need to be used and the weight of the flue can be supported by the unit and located using default methods. Ensure appropriate bracing is used.

Flue height above roof

The flue pipe must extend 600mm above the highest point of the roof if within 3000mm. If outside 3000mm, the pipe must extend until 3000mm is achieved to the roof structure (see fig 1). The flue pipe must continue until clear if it is within 3000mm of any structure, including but not limited to second story, neighbouring properties, trees and any nearby structures.

FIG 1.

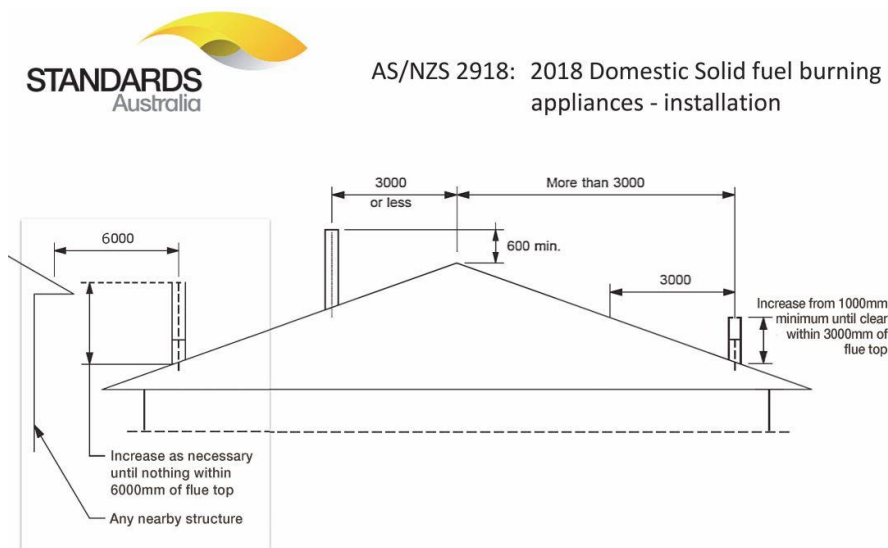

Cut out point for ceiling penetration

Using the installation manual for the fireplace being installed, position the fireplace into the desired location ensuring that all clearances stipulated by the fireplace manufacture are achieved. Once in position, check using a laser or plum bob the location of the flue penetration in the roof cavity.

The flue will need to pass through a section of ceiling which can house the main flue bracing bracket. Ideally this is between two roof trusses which can be used to mount the flue bracing bracket. (FIG 2) If this cannot be achieved, additional frame work in the roof will be required to house the flue bracing bracket.

Please ensure clearances are met when fitting the flue bracing bracket and constructing any additional frame work. If the roof cavity is used as usable living or storage space or has blown in insulation, an attic shield is recommended to ensure the 25mm clearance to the Safety Vent AIR 200 pipe.

FIG 2

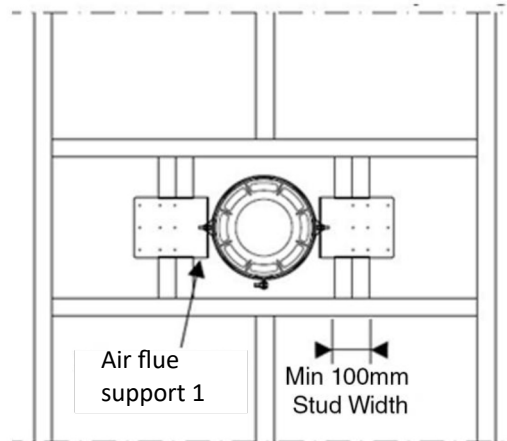

Fitment of VisionLINE Safety Vent AIR pipe

Measure the distance drop from the top of the air flue support 1 location to the plaster. Mark the safety vent pipe for the same measurement plus an additional 70mm to protrude into the room unless desiring more. This will ensure the minimum clearance of 150mm from the stove pipe to the plaster is achieved.

Fit this marked section of VisionLINE AIR pipe into the Air Flue support 1 bracket, secure using self tapping screws and tighten the bracket and place ensuring that enough pipe has passed down through the ceiling to meet the clearance requirements before using the conversion piece to convert to VL double wall stove pipe (see FIG 3).

FIG 3.

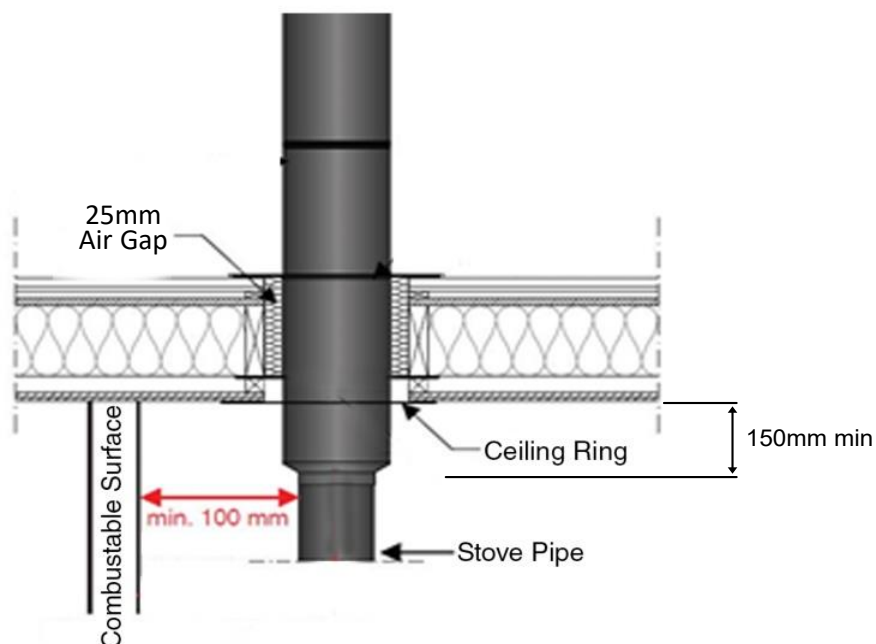

Once in desired position, tighten off the flue brace bracket and use self-tap screws (not supplied) to fix off the Safety Vent AIR pipe. The 25mm gap between a combustibile ceiling and the Safety Vent AIR pipe can be covered using the 80mm steel ceiling ring flush to the ceiling with no airgap required. (FIG 3)

This can be secured using plaster screws (not supplied) or Hi-temp silicone.

Connecting VisionLINE AIR pipe

Once the flue brace bracket is secure and in place, you can now start to attach further lengths of pipe to continue and penetrate the roof. VisionLINE safety vent AIR is a twist lock flue, sections should be pushed together and then ensured they are twisted into the locked position in the clockwise direction. VisionLINE safety vent AIR CANNOT be cut, if you require smaller sections, please contact your distributor.

Safety Vent pipe does not require securing screws or rivets once twist locked together, however if connecting multiple sections together to drop into a cavity it can be secured in this way.

Roof Penetration

Once the safety vent AIR flue has passed though the roof, the optional roof stabiliser bracket can be used for further bracing and support (FIG 4)

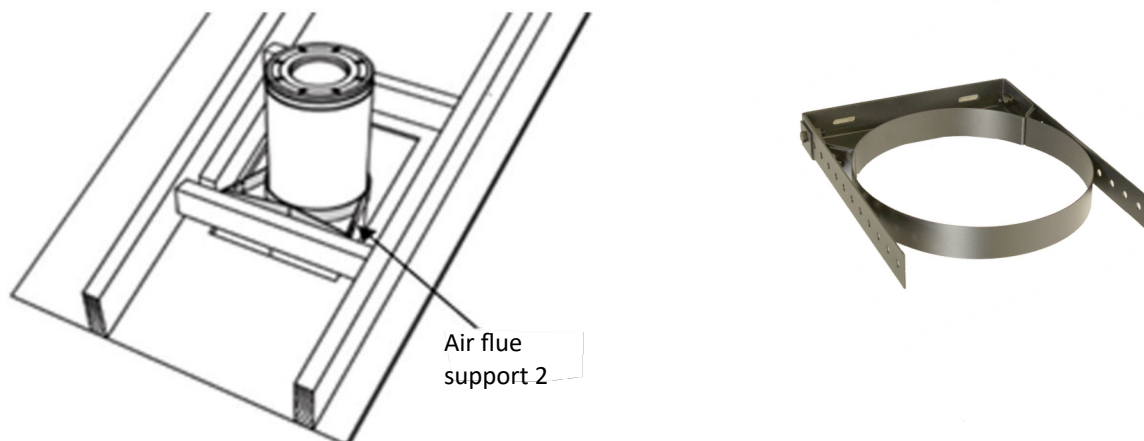

At the roof level, use appropriate flashing to weather seal the penetration. (Not supplied)
Continue the safety vent AIR pipe past the roof penetration until the height satisfies AS/NZS 2918
(Refer to FIG 1)

VisionLINE Safety Vent AIR pipe can run at a height of 3 meters past the highest flue bracing support without the need for additional bracing. Pipe running past this distance will require further support. Once the termination height is achieved, the flue cap can be fitted off by twist locking into place.

FIG 5.

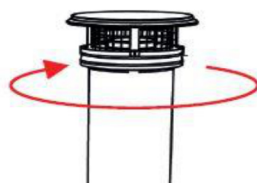

Fitting double wall stove pipe

Once the VisionLINE Safety Vent AIR pipe is in place, you can now fit the double wall stove pipe inside the house to connect to your fireplace. Fit the Safety Vent AIR to stove pipe adaptor to the protruding AIR flue pipe. You can now transition to the stove pipe. VL Stove pipe has crimped join connection and comes in several lengths as well as telescopic adjustable sections for easy fitment. It is necessary to secure the stove pipe sections together using black rivets (not supplied) once leveled.

If your fireplace has a shallow, inline or recessed flue spigot, it may be necessary to install a **flush spigot adapter** (VF-3-80-092) to connect the stove pipe to the fireplace. This adapter can be cut down so there is minimal exposed 8inch showing. It is not recommended to have the stove pipe resting hard on the appliance top.

Use of the air intake system

If you are using the air intake system for balanced flue wood fireplaces, the flue system is compatible with direct spigot air intake.

If the fireplace uses a rear or floor entry intake system, a T piece section can be used (Part number VF-3-80-090) as the final VL stove pipe section which can then be connected to the rear air inlet either by flex pipe (not supplied) or the VisionLINE adjustable intake (part number VF-3-60-091). See FIG 6.

IMPORTANT - For the air intake to work effectively, the insulation inside the T-section must be fitted. Removal will result in a loss of vacuum to the unit and air starvation for the fire may occur. A flush spigot adapter may be required for some heaters in this case.

To fit this, remove the insulation, fit the flush spigot adapter and replace the insulation.

To connect the fresh air adapter with the stove, the supplied 100mm pipe is required to be cut to suit and connected with the supplied adjustable elbow if required.

A floor entry connection to the heater may require the use of the 100mm adjustable elbow 0 - 90 degrees. 45 and 90 degree fixed elbows may be used to substitute if necessary.

IMPORTANT - The snorkel connections between the adjustable 100mm pipe, T-section and lower air intake must be sealed with a bead of high-temp silicone to ensure no loss of vacuum on the air intake. Snorkel can be replaced by 90° elbows and 100mm straight pipe.

IMPORTANT - If the unit does not have air intake capability, for maximum house efficiency and compliance to BAL-40 and BAL-FZ requirements you must seal the starter pipe with a 25mm fibre insulation rope.

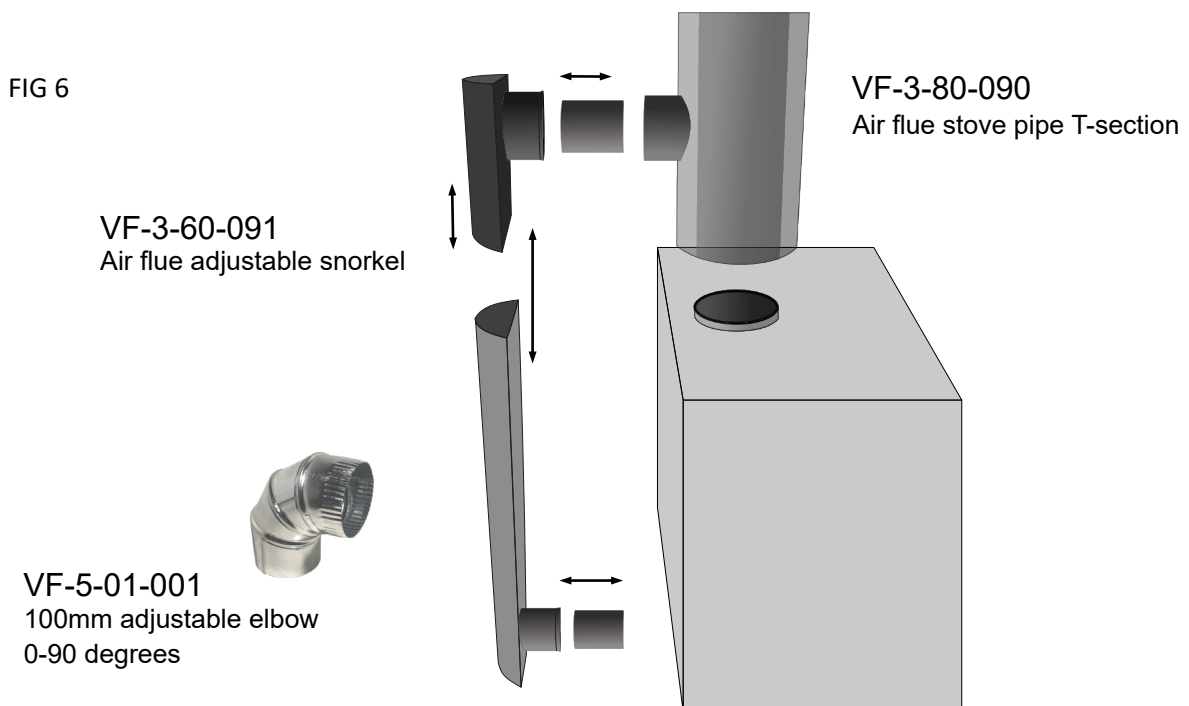

Use of bends

Bends can be used on this flue system. Either the stove pipe flue (45°) or the VisionLINE safety vent flue (15° and 30°) can be offset. A maximum of two (2) sets of elbows can be used. A maximum of 1800mm in total can be run at a 45° angle.

If you are offsetting VisionLINE safety vent pipe, you MUST brace the offset appropriately. 2

VisionLINE braces must be used to support the flue. (See fig 7) Furthermore, the joints must be sealed using VisionLINE clamp braces (See fig 7).

It is permissible to join a 15° and 30° safety vent elbow to achieve a 45° offset if required.

FIG 7

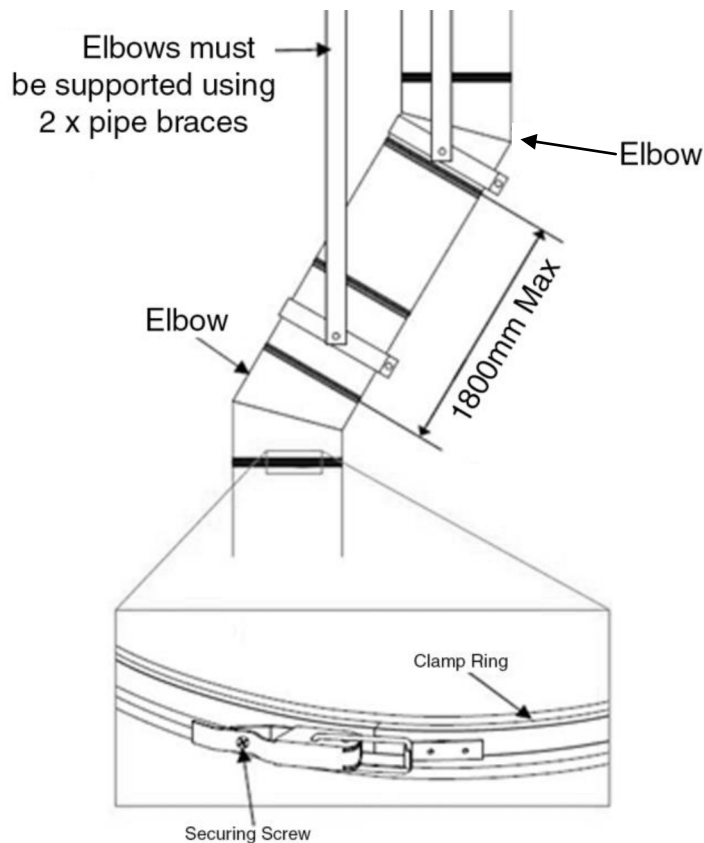

VF-3-80-246
Elbow support bracket kit



Offset amounts

Elbow	EXTENSION between	A	B	C
15°	0	418	55	0
	200mm	612	107	52
	250mm	659	120	65
	500mm	877	178	123
	1000mm	1360	307	252
	1200mm	1575	365	310
30°	0	481	129	0
	200mm	652	230	100
	250mm	696	255	125
	500mm	890	367	238
	1000mm	1323	618	490
	1200mm	1517	730	599

FIG 8

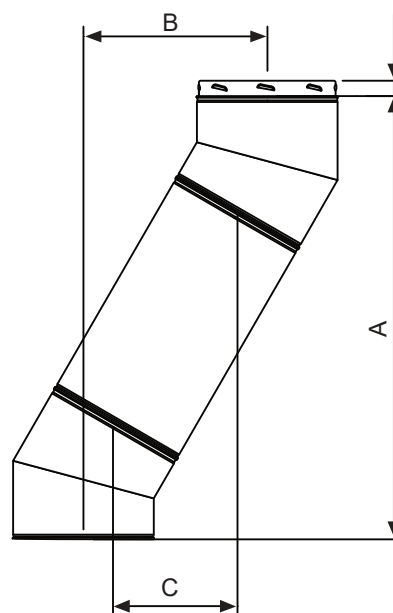

Final Inspection

Once the flue system has been installed, a final inspection should be carried out.

Particular attention should be paid to:

- 25mm clearance requirement to combustibles from Safety Vent AIR pipe
- 100mm clearance requirement to combustibles from stove pipe
- 150mm clearance from transition to ceiling (stove pipe to safety vent) requirements
- Flue height requirements per AS/NZS 2918

Standard 8" flue components



#	Code	Description
1	VF-8-80-001	AIR FLUE 8" RAIN CAP
2	VF-8-80-203	AIR FLUE 8" SAFETY VENT 1000MM
3	VF-8-80-202	AIR FLUE 8" SAFETY VENT 500MM
4	VF-8-80-201	AIR FLUE 8" SAFETY VENT 250MM
	VF-8-80-200	AIR FLUE 8" SAFETY VENT 200MM
5	VF-8-60-010	AIR FLUE 8" SAFETY VENT 15 ELBOW
5	VF-8-80-206	AIR FLUE 8" SAFETY VENT 30 ELBOW
6	VF-3-80-246	AIR FLUE ELBOW SUPPORT BRACKET KIT
7	VF-8-80-003	AIR FLUE SUPPORT 2
8	VF-8-80-002	AIR FLUE SUPPORT 1
9	VF-8-80-108	AIR FLUE STOVE PIPE TO SAFETY VENT TRANSITION
10	VF-3-80-110	AIR FLUE CEILING RING - 80MM
11	VF-3-80-105	AIR FLUE STOVE PIPE 620-1080MM ADJUSTABLE
12	VF-3-80-104	AIR FLUE STOVE PIPE 420-610MM ADJUSTABLE
13	VF-3-80-145	AIR FLUE STOVE PIPE 45 ELBOW
14	VF-3-80-107	AIR FLUE STOVE PIPE 1200MM
15	VF-3-80-106	AIR FLUE STOVE PIPE 1000MM
16	VF-3-80-102	AIR FLUE STOVE PIPE 500MM
17	VF-3-80-100	AIR FLUE STOVE PIPE 250MM
18	VF-5-01-001	100MM ADJUSTABLE ELBOW 0-90 DEGREES
19	VF-3-80-090	AIR FLUE STOVE PIPE T SECTION
20	VF-3-80-091	AIR FLUE ADJUSTABLE SNORKEL

Component specs

Below the ceiling

Stove pipe elbow

VF-3-80-145

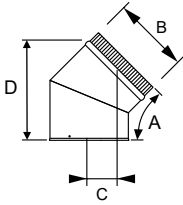

A	45°
B	243 mm
C	99 mm
C X 2	188 mm
D X 2	

Stove pipe

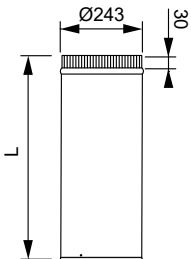

Part number	Joined length	Total length
VF-3-80-100	220mm	250mm
VF-3-80-102	470mm	500mm
VF-3-80-106	970mm	1000mm
VF-3-80-107	1170mm	1200mm

Flush spigot adapter

VF-3-80-093

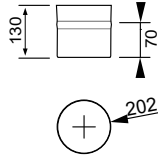

To be used when the fireplace has a hidden spigot

T-Section

VF-3-80-090

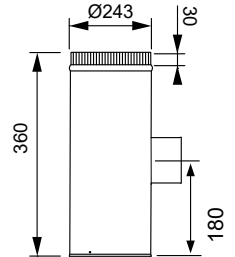

Adjustable Stove pipe

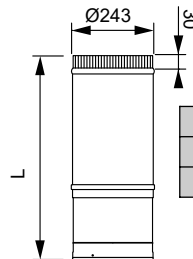

Part number	L min.	L Max.
VF-3-80-104	300mm	600mm
VF-3-80-105	500mm	1000mm

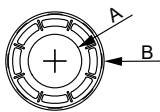

Stove pipe to safety vent adapter

VF-3-80-108

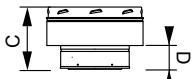

A	Ø200 mm
B	Ø325 mm
C	193 mm
D	65 mm
E	Ø243 mm

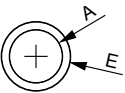

Ceiling Ring

VF-3-80-110

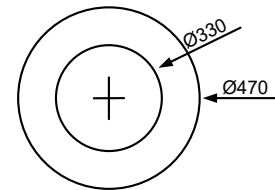

Above the ceiling

Safety Vent Cowl

VF-8-80-001

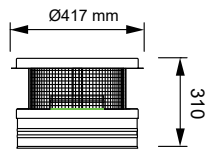

Safety Vent Elbow

VF-8-80-010 15 DEGREE

VF-8-80-206 30 DEGREE

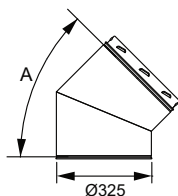

Part number	Angle
VF-8-80-010	15°
VF-8-80-206	30°

Offset amounts can be found on page 7 (FIG 8).

Safety Vent Pipe

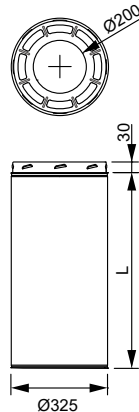

Part number	Joined length	Total Length
VF-8-80-200	200mm	230mm
VF-8-80-201	250mm	280mm
VF-8-80-202	475mm	505mm
VF-8-80-203	975mm	1005mm
VF-8-80-204	1198mm	1228mm

This page is intentionally blank



PO Box 5051 Burnley, 3121
Phone: (03) 9429 5573
Email: info@visionlinefire.com.au
Web: visionlinefire.com.au