

DEEP FULLY RECESSED ELECTRIC FIREPLACE

Model# : ■ VL-VESTA-50 ■ VL-VESTA-70

OWNER'S MANUAL

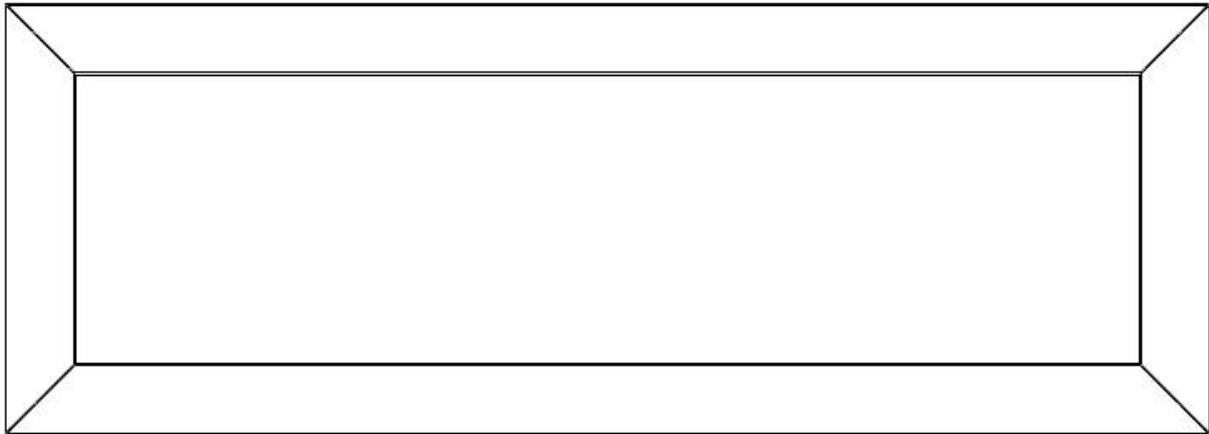

50"/ 70"- Wall Mounted/Recessed Electric Fireplace

AC 220-240V 50Hz 1400-1600W

⚠ WARNING

Read and understand this entire owner's manual, including **all safety information**, before plugging in or using this product. Failure to do so could result in **fire, electric shock, or serious personal injury**.

⚠ CAUTION

Keep this owner's manual for future reference. If you sell or give this product away, **make sure this manual accompanies this product**.

visionLINE™
fireplace systems

IMPORTANT SAFETY INFORMATION!

WARNING

- **Read all instructions before using this fireplace!**
- **DO NOT** operate any fireplace with a **damaged cord or plug** or after the **fireplace malfunctions**, has been **dropped** or **damaged in any manner**. Discard fireplace, or return to authorized service facility for examination and/or repair.
- **DO NOT** run **power cord** under carpeting. **DO NOT** cover power cord with throw rugs, runners, or similar coverings. **DO NOT** route power cord under furniture or appliances. Arrange power cord **away from traffic** area, and where it will not be tripped over.
- **Connect to properly grounded outlets ONLY.**
- **DO NOT** insert or allow foreign objects to enter any ventilation or exhaust opening, as this may cause **electric shock** or **fire**, or **damage the fireplace**.
- To prevent a possible fire, **DO NOT** block air intakes or exhaust in any manner. Doing so could cause a **fire**. **DO NOT** use on soft surfaces, like a bed, where openings may become blocked.
- A fireplace has **hot and arcing or sparking parts inside**. **DO NOT** use it in areas where **gasoline, paint, or flammable liquids** are used or stored.
- **Use this fireplace only as described in this manual. Any other use not recommended by the manufacturer may cause fire, electric shock, or injury to persons.**
- **AVOID FIRE!** Regularly inspect all air vents to make sure they are free from dust, lint, or other blockage. **Unplug the unit** and clean with a **vacuum ONLY**. **DO NOT** rinse or get wet.
- **NEVER** hang this unit on a wall **directly below an electrical outlet**.
- **NEVER** permanently install in a recessed area of the wall. This may result in **blocked air flow, overheating, or fire**.
- **ALWAYS** mount to wall bracket before use. **DO NOT** set on the floor, or other surface, to use.
- **NEVER** use a wall mount bracket from another manufacturer.
- **For residential use only! NOT for commercial use!** Any commercial or public use of this fireplace **voids all warranties**, and could cause **injury**.
- This product is **not intended** to be a **primary heat source**. It is for **supplemental heat only**.
- **INDOOR and OUTDOOR use!**
- **Risk of electric shock! DO NOT OPEN!** No user-serviceable parts inside!
- **NEVER** modify this fireplace. Doing so could result in personal **injury** or property **damage**. Modification of this fireplace **completely voids all warranties**.
- **ALWAYS** turn this fireplace off before unplugging it from the outlet.
- **ALWAYS** disconnect this unit from the **power supply before** performing any assembly or cleaning, or before relocating the electric fireplace.

- **NEVER** leave this fireplace unattended. **ALWAYS** unplug this fireplace when not in use.
- **ONLY** use this fireplace on a **220-240V AC 10-Amp grounded circuit**. **NEVER overload the circuit**. If this fireplace trips the circuit breaker, unplug all other appliances on the same circuit before the next use. Avoid plugging other appliances into the same circuit as this fireplace.
- **NEVER** plug this fireplace into an outlet that is **old, cracked**, or has any **loose wires or connections**. Plugging this fireplace into a faulty outlet could result in **electric arcing** within the outlet that could cause the **outlet to overheat or catch fire**.
- **ALWAYS** check your fireplace cord and plug connections with **each use!**
 - i) **MAKE SURE** the plug fits tight in the outlet! Faulty wall outlet connections or loose plugs can cause the outlet to overheat.
 - ii) **fireplaces draw more current** than small appliances. **Overheating** may occur even if it has not occurred with the use of other appliances.
 - iii) During use **check frequently** to see if the **plug outlet or faceplate is HOT!**
 - iv) If the outlet or face plate is **HOT, discontinue use immediately** and have a qualified electrician inspect and/or replace the faulty outlets.
- **SAVE THESE INSTRUCTIONS!**

Preparation









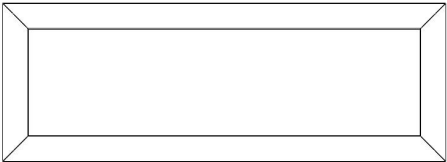

This product includes a **GLASS panel!** Always use **extreme caution** when handling **glass**. Failure to do so could result in **personal injury** or **property damage**.

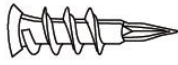
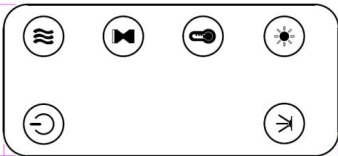
Remove all parts and hardware from the carton and place them on a clean, soft, dry surface. Parts and assembly steps are grouped for free-standing or wall-hanging use. Check the parts list to make sure nothing is missing. Dispose of packaging materials properly. Please recycle whenever possible.

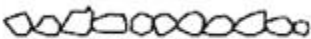
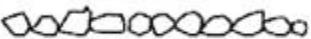
You will need the following tools (not included): Phillips screwdriver; stud finder; level; tape measure; electric drill; 1/4" wood drill bit, hammer.

Parts and Hardware

 <p>A – Fireplace</p>	 <p>B – Wood Screws</p>	 <p>C – Drywall Anchors</p>
	 <p>RC – Remote Control</p>	 <p>D- Logs and stones set (Fixed on ember bed)</p>
 <p>E - Crystals</p>	 <p>F-Pebbles</p>	 <p>G- Plastic Tray</p>
 <p>H- L bracket</p>	 <p>I- ST4x12 screws</p>	

Installation and Assembly

Front View of Fireplace

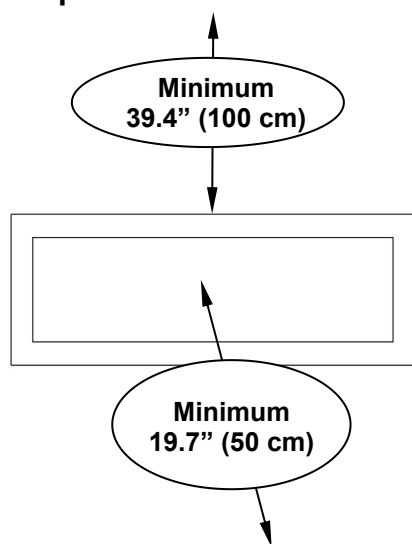

Step 1. Find a safe location.

Minimum clearance above:
39.4" (100 cm).

Minimum clearance from the front
and sides: 19.7" (50 cm).

Choose a location near an outlet so
an extension cord is not required.

DO NOT position the unit **directly**
below a power outlet.

See **Safety Information** on pages
2 and 3 for warnings about **safe**
placement, safe installation, and
proper use of this product.



ALWAYS unplug this fireplace before assembly or cleaning, or before relocating. Failure to do so could result in **electric shock, fire, or personal injury.**

Wall Recessed Installation

STEP 1. Select a dry wall to open a hole for fireplace box. Size of holes as below chart

Model No.	W	H	T
VL-VESTA-50	1185mm	450mm	170mm
VL-VESTA-70	1720mm	450mm	170mm

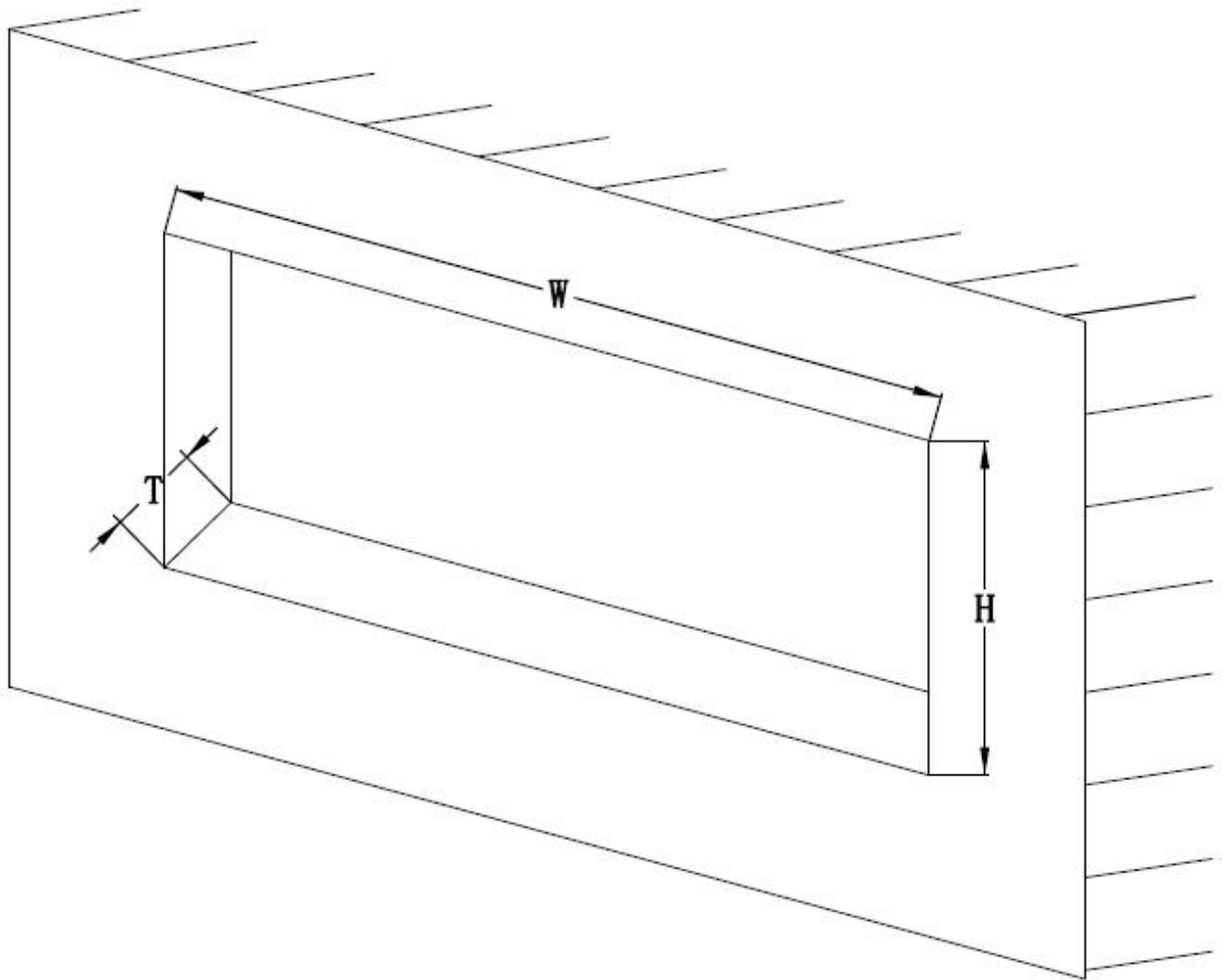

Figure (A)

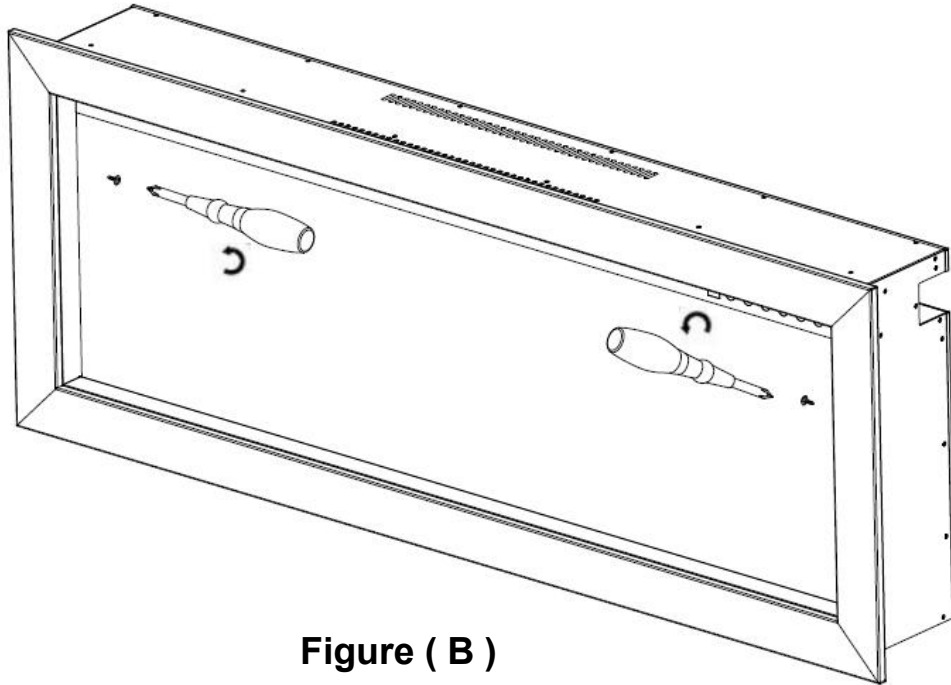

Figure (B)

STEP 2. Place the fireplace to a **soft clean place**. using the screw driver to take off the **TWO** screws in both sides. **Figure (B)**

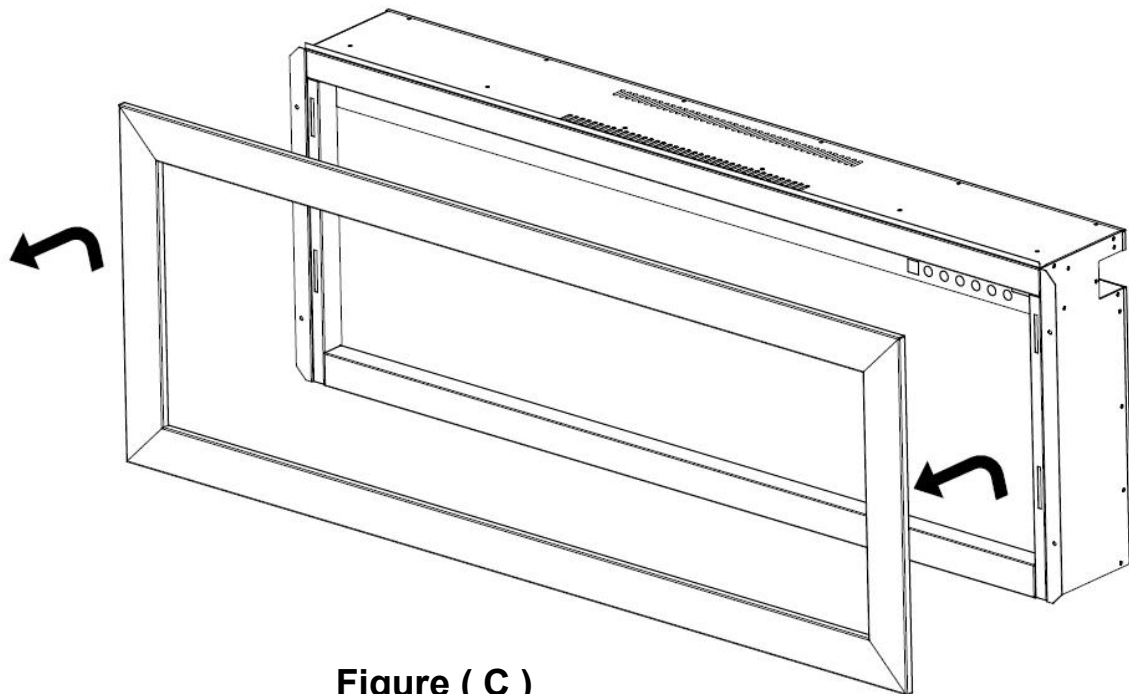

Figure (C)

STEP 3. Have two adults to pull the trim up, then take them out of the fireplace box. **Figure (C)**

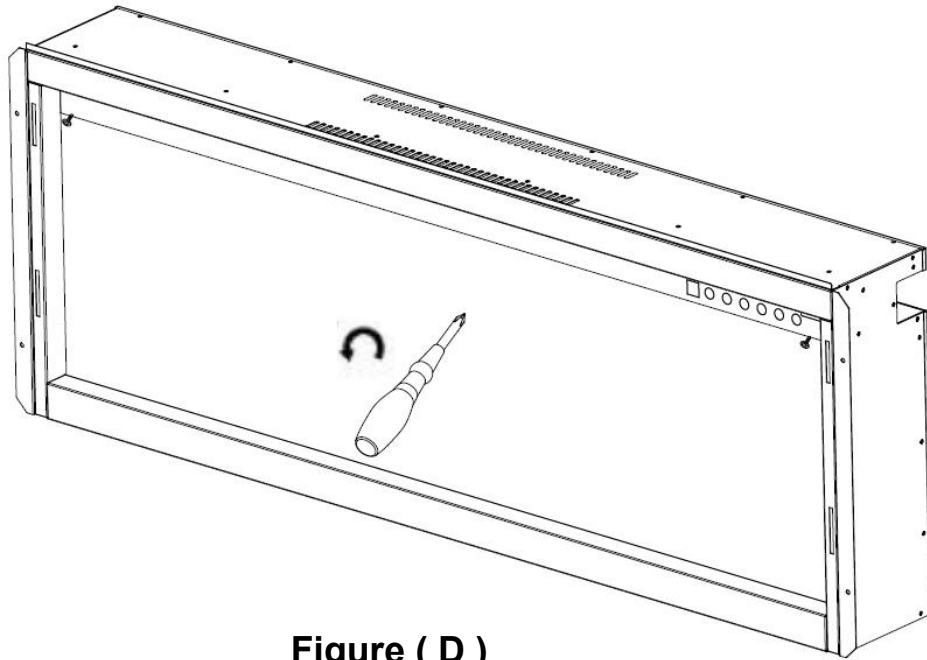

Figure (D)

STEP 4. Using the screw driver to take off the 2 screws as above **Figure (D)**, have two adults to take out the glass panel **Figure (E)** and move it to a clean soft place to avoid the scratching.
NOTICE: If you prefer initial ember bed, you can skip this step.

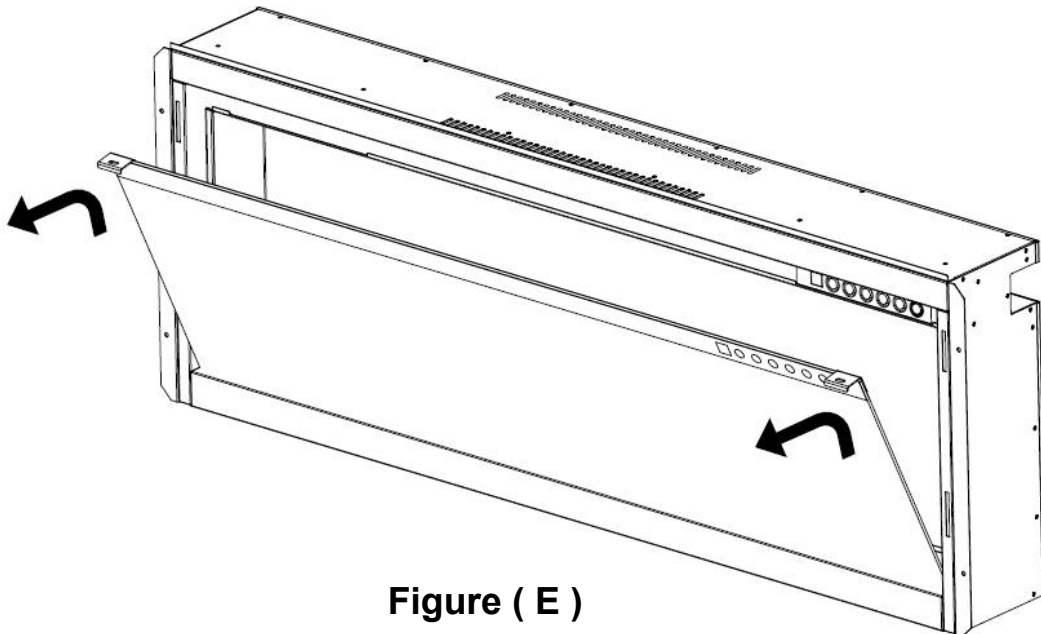

Figure (E)

STEP 5. Have two adults to lift the fireplace box and put it into the opened hole. Fixing the FOUR wall screws in each side of the fireplace box. **Figure (F)**

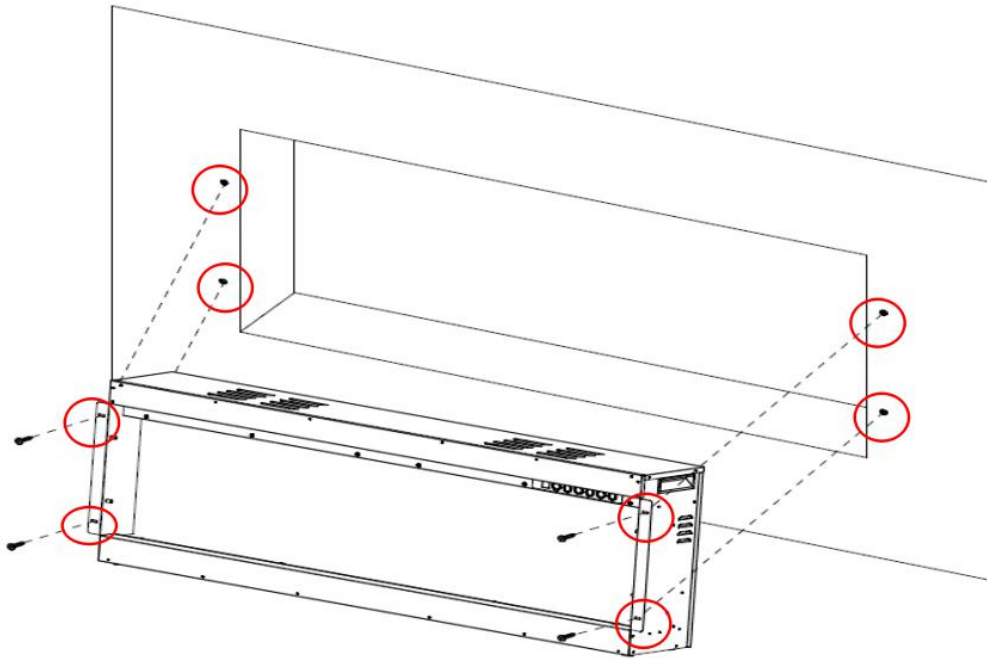

Figure (F)

STEP 6. Place the Decorative Crystals or Pebbles on the designed slot and even with them, **Figure (G)**

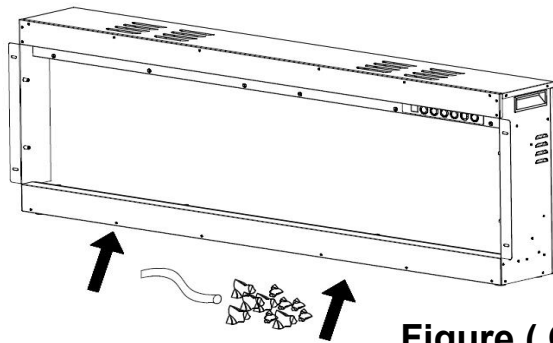

Figure (G)



STEP 7. After Placing the decorative crystals and Drift log pieces on the designed slot and even with them from side to side . Move and screw back the glass panel and metal trim.
(Repeat as **Fig B,C,D,E**)

Wall Mounted Installation

STEP 1. Take off wall bracket from the behind of fireplace, and keep it for next step. see below Figure (A).

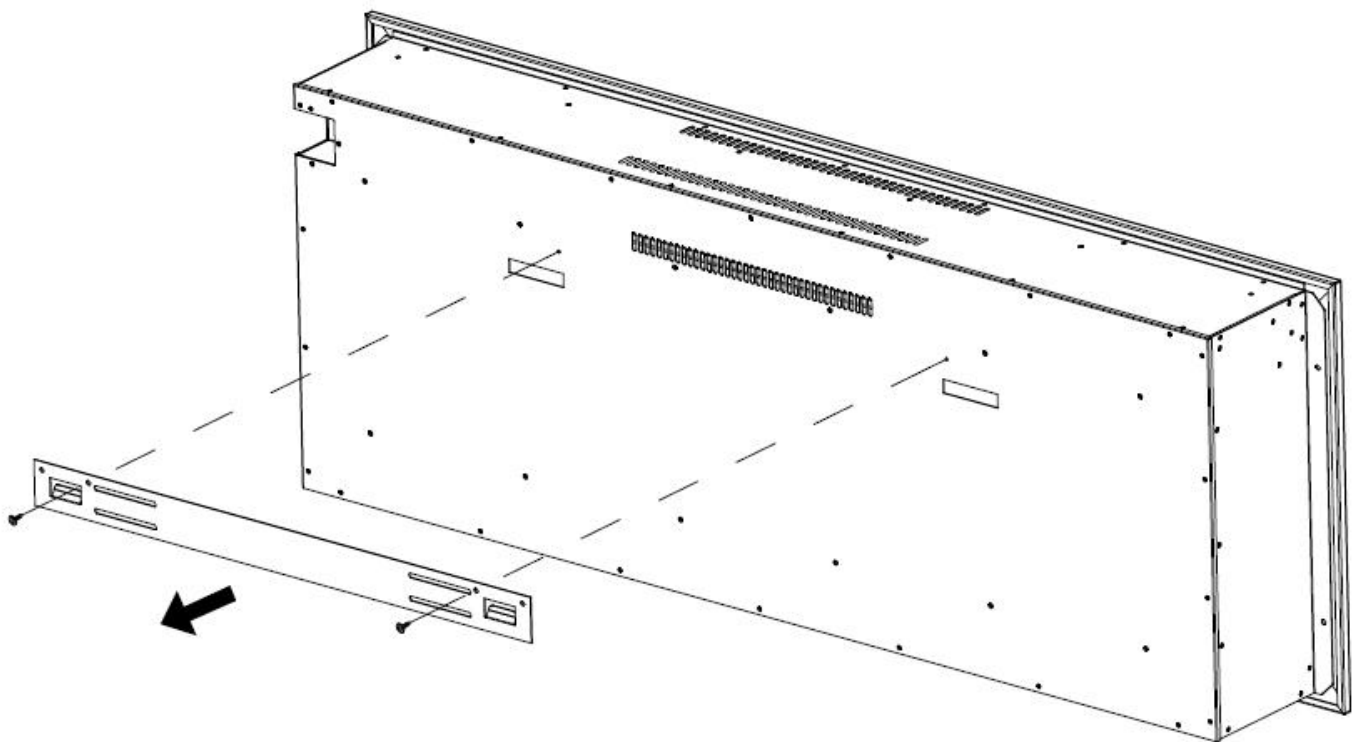
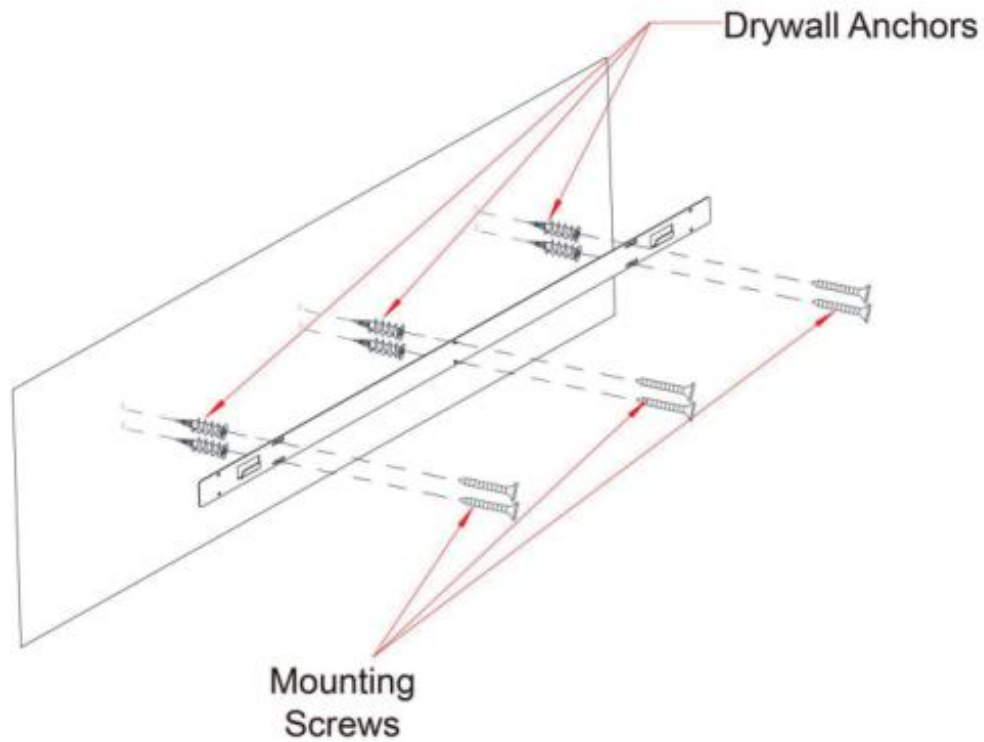
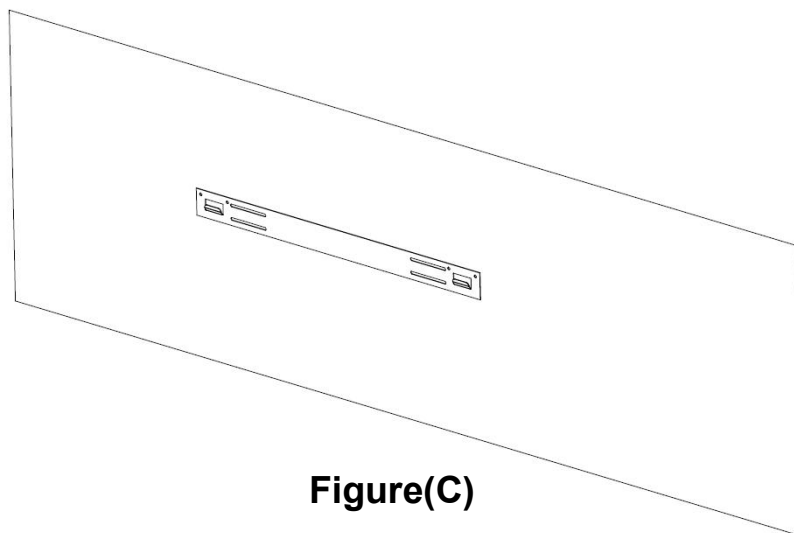

Figure (A)

STEP 2. Fix wall bracket with Mounting screws (B) , Drywall Anchors(C), and spirit level (not included). Make sure wall bracket is horizontally fixed on wall. See Figure(B) and (C).



Figure(B)



Figure(C)

STEP 3. Hang fireplace on wall bracket by two adults. Make sure fireplace is securely hang on wall. See figure (D)

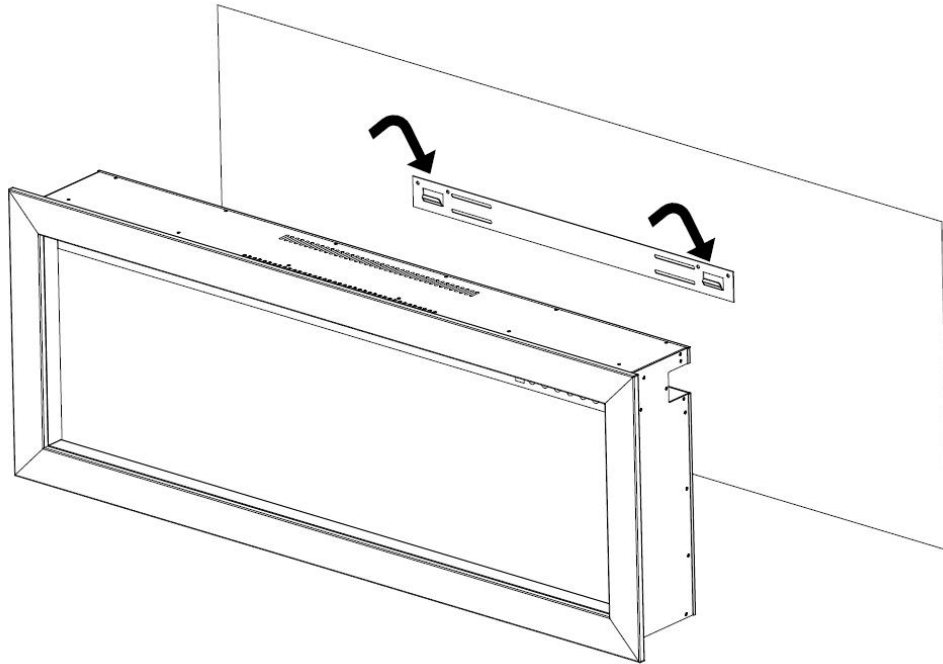

Figure (D)

STEP 4. Take off one screw on the bottom of fireplace and fix L bracket(H) on bottom of fireplace with ST4x12 screw(I). Then fix L bracket on wall with Drywall anchor (C) and wood screw(B). See Figure (E) and (F).

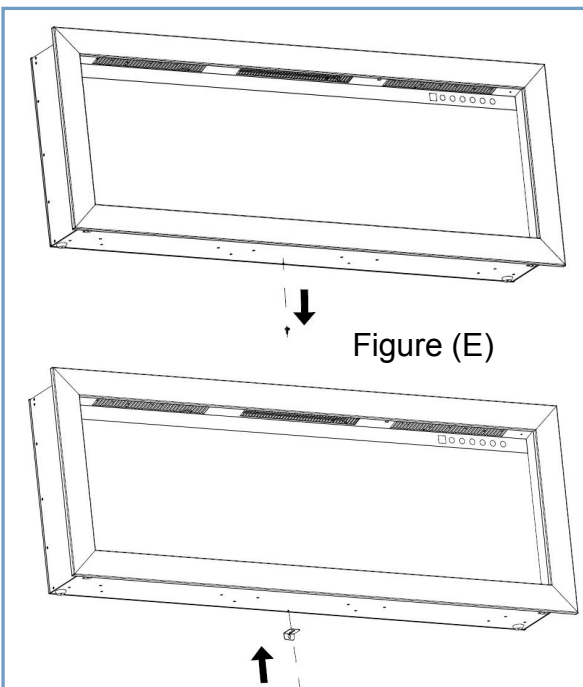

Figure (E)

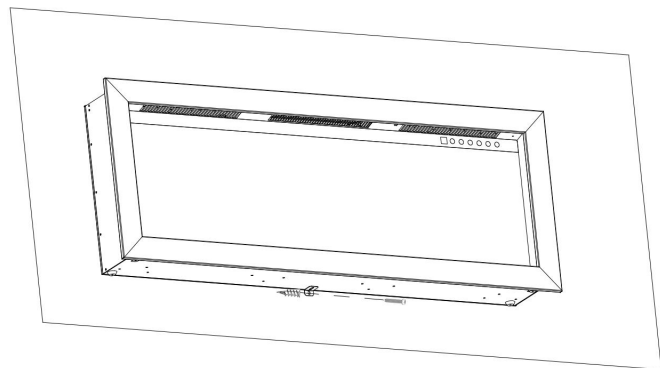

Figure (F)

Operation



Read and understand this entire owner's manual, including **all safety information**, **before plugging in** or **using** this product. Failure to do so could result in **electric shock, fire, serious injury, or death.**

Power

Plug the power cord into a 220-240 Volt 10 Amp grounded outlet (see **IMPORTANT SAFETY INFORMATION** on **Pages 2 and 3**). Make sure the outlet is in good condition and that the plug is not loose. **NEVER** exceed the maximum amperage for the circuit. **DO NOT** plug other appliances into the same circuit.

Methods of Operation



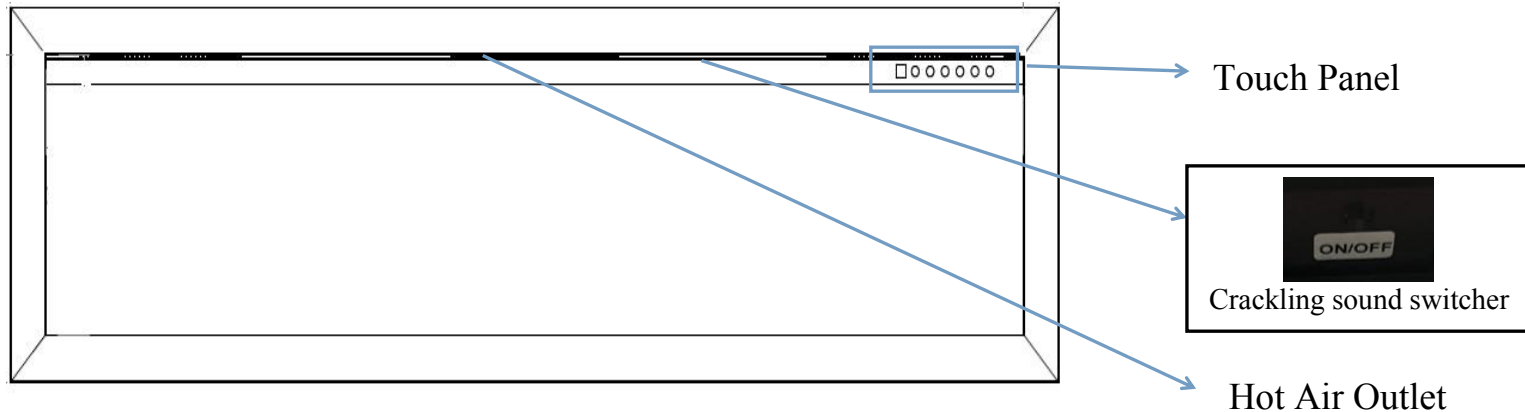
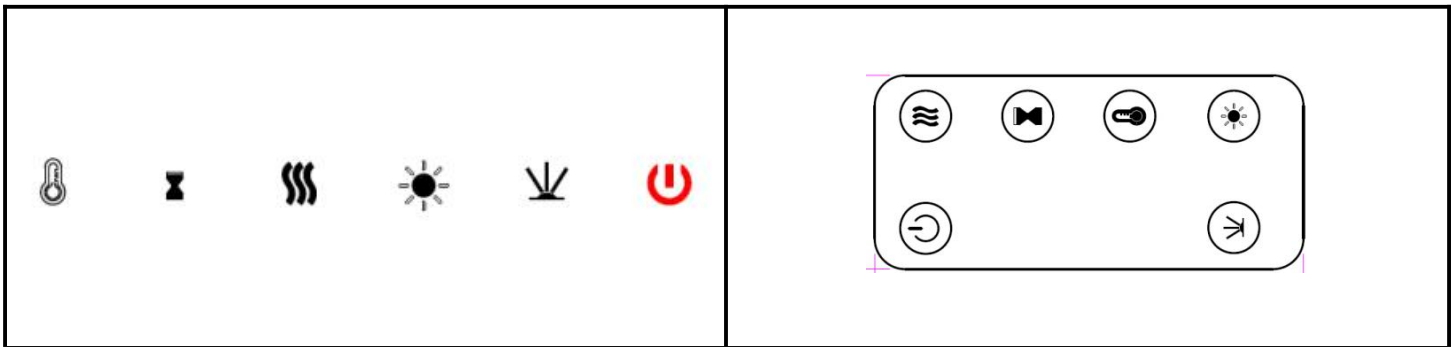

This electric fireplace can be operated by the TOUCH PANEL, located on the right side panel of the fireplace (see figure below), or by the battery-powered REMOTE CONTROL.

The operation and functions of the two methods are the same.

Before operating, please review the **IMPORTANT SAFETY INFORMATION** on **Pages 2 and 3**, and heed all warnings.



Remote Control & Touch Panel Operation

BUTTON	FUNCTION	ACTION & INDICATION																																							
 POWER	<p>ON: Enables control panel functions and remote control. Turns on flame effect.</p> <p>OFF: Disables control panel functions and remote control. Turns off flame effect.</p>	<ol style="list-style-type: none"> Press once. Indicator light turns on. Power turns on. All functions enabled. Press again. Flame effect turns off. Unit goes to standby. All functions turn off. 																																							
 TIMER	<p>TIMER button: Controls timer settings to turn off fireplace at selected time.</p> <p>Settings range from 0.5 hours to 8 hours.</p>	<ol style="list-style-type: none"> Press once. Indicator light turns on. Timer is set to 0.5 hours. Press again until desired setting is reached. Indicator lights show setting. 																																							
 HEATER	<p>HEATER button: Turns heater on and off.</p> <p>NOTE: The heater only works when the flame effect is on. If the flame effect is off, the heater will not turn on.</p> <p>NOTE: To prevent overheating, the heater fan will blow cool air for 8-10 seconds before the heater turns on, and after the heater turns off.</p>	<ol style="list-style-type: none"> Press once. Indicator lights up. Fan blows cool air for 10 seconds. 750W heater turns on and blows warm air. Press again. Indicator lights up. 1500W heater turns on and blows hot air. Press again. Heaters turn off. The fan blows cool air for 10 seconds to allow heater to cool down, then turns off. 																																							
 TEMP	<p>TEMPERATURE button: Turns heater on and off.</p> <p>NOTE: Press the button for 5 seconds, the temperature setting will switch from °C to °F. Same way from °F to °C.</p>	<ol style="list-style-type: none"> Press once: Touch panel indicator becomes active. Press again: until desired setting is Reached. Digital display shows setting circles as below: <table border="1" data-bbox="901 1281 1518 1375"> <thead> <tr> <th>Display</th> <th>0</th> <th>1</th> <th>2</th> <th>3</th> <th>4</th> <th>5</th> <th>6</th> <th>7</th> <th>8</th> <th>9</th> <th>10</th> <th>N</th> </tr> </thead> <tbody> <tr> <td>°C</td> <td>20</td> <td>21</td> <td>22</td> <td>23</td> <td>24</td> <td>25</td> <td>26</td> <td>27</td> <td>28</td> <td>29</td> <td>30</td> <td>C</td> </tr> <tr> <td>°F</td> <td>68</td> <td>70</td> <td>72</td> <td>74</td> <td>76</td> <td>78</td> <td>80</td> <td>82</td> <td>84</td> <td>86</td> <td>88</td> <td>F</td> </tr> </tbody> </table>	Display	0	1	2	3	4	5	6	7	8	9	10	N	°C	20	21	22	23	24	25	26	27	28	29	30	C	°F	68	70	72	74	76	78	80	82	84	86	88	F
Display	0	1	2	3	4	5	6	7	8	9	10	N																													
°C	20	21	22	23	24	25	26	27	28	29	30	C																													
°F	68	70	72	74	76	78	80	82	84	86	88	F																													
 EMBER LIGHT	<p>LED Ember light button: Makes the colour on bottom effect changing.</p> <p>NOTE: Ember colour effect stays on until power button is turned off.</p>	<p>01-Orange (default) 02-Red 03-Blue 04-Yellow 05-Green 06-Purple 07-Azure 08-Carmine 09-White 10-Pink 11-Auto-cycle among above colours (NOTE: It will take 8.5 seconds to switch between colours.) 12-Lock to the desired colour</p>																																							

 <p>EMBER LIGHT BRIGHTNESS</p>	<p>EMBER LIGHT BRIGHTNESS button : Dimmer and brighter the brightness of ember bed light.</p>	<p>Settings: L4- Brightest (default) L3-Bright L2-Medium L1-Low L0-Off L5-Gradual brightening effect from L1-L4</p>
--	--	--

NOTICE When the fireplace is first turned on, a slight odor may be present. This is normal and should not occur again unless the fireplace is not used for a long period of time.

NOTICE To improve operation, **aim** the remote control at the front of the fireplace. **DO NOT press the buttons too quickly.** Give the unit time to respond to each command.

Temperature Limiting Control

This heater is equipped with a Temperature Limiting Control. Should the heater reach an unsafe temperature, the heater will automatically turn OFF. To reset:

1. Unplug the power cord from the outlet.
2. Turn the ON/OFF switch on the CONTROL PANEL to OFF. **Wait 5 minutes.**
3. Inspect the fireplace to make sure no vents are blocked, or clogged with dust or lint. If they are, use a vacuum to clean the vent areas.
4. With the POWER switch in the OFF position, plug the power cord back into the outlet.
5. If the problem continues, have your outlet and wiring inspected by a professional.

Remote Control Battery Information

- This remote control uses CR2025 **battery (included).**
- Instructions for battery installation are on the Remote Control battery compartment.

 **NEVER** dispose of batteries in **fire**. Failure to observe this precaution **may result in an explosion.** Dispose of batteries at your local hazardous material processing center.

Care and Maintenance

Cleaning



ALWAYS turn the fireplace **OFF** and **unplug the power cord from the outlet** before cleaning, performing maintenance, or moving this fireplace. Failure to do so could result in **electric shock, fire, or personal injury**.



NEVER immerse in water or **spray with water**. Doing so could result in **electric shock, fire, or personal injury**.

Metal:

- Buff using a soft cloth, slightly dampened with a citrus oil-based product.
- **DO NOT** use brass polish or household cleaners as these products will damage the metal trim.

Glass:

- Use a good quality glass cleaner sprayed onto the cloth or towel. Dry thoroughly with a paper towel or lint-free cloth.
- **NEVER** use abrasive cleansers, liquid sprays, or any cleaner that could scratch the surface.

Vents:

- Use a vacuum or duster to remove dust and dirt from the fireplace and vent areas.

Plastic:

- Wipe gently with a slightly damp cloth and a mild solution of dish soap and warm water.
- **NEVER** use abrasive cleansers, liquid sprays, or any cleaner that could scratch the surface.

Maintenance



Risk of electric shock! DO NOT OPEN any panels ! No user-serviceable parts inside!



ALWAYS turn the fireplace **OFF** and **unplug the power cord from the outlet** before cleaning, performing maintenance, or moving this fireplace. Failure to do so could result in **electric shock, fire, or personal injury**.

Electrical and Moving Parts:

- The fan motors are lubricated at the factory and will not require lubrication.
- Electrical components are integrated in the fireplace and are not serviceable by the consumer.

Storage:

- Store fireplace in a clean dry place when not in use.



WARNING! NO SERVICING of the internal or electrical parts should be performed by the consumer. Do not service the unit yourself.

Visionline Fireplaces
444 Swan Street
Richmond Victoria AU
1300 219 875